

6GHZ 1W 4DB QMA ATTENUATOR

R411.704.124

Series :
ATTENUATEUR

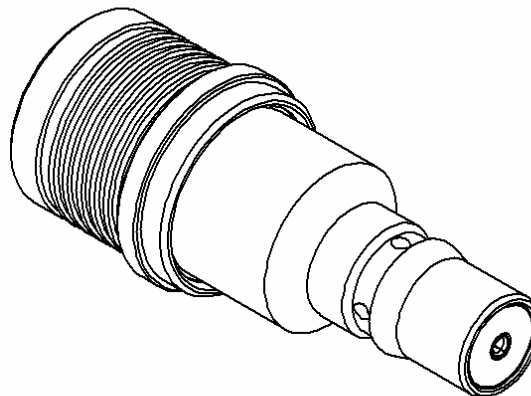
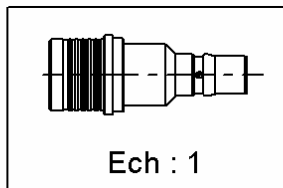
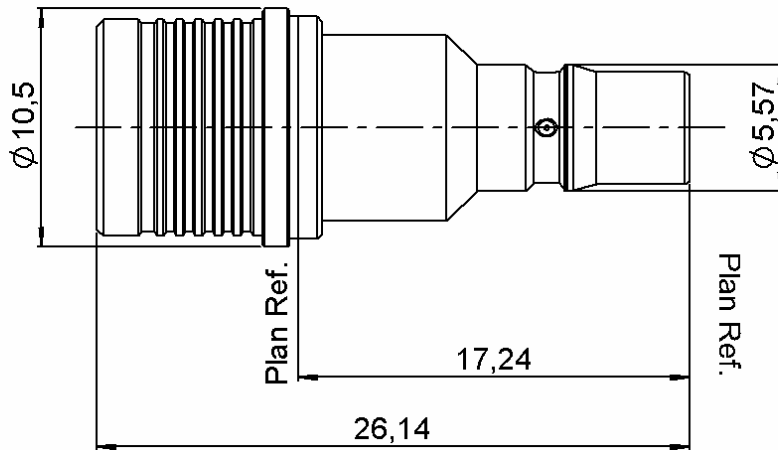

All dimensions are in mm.

COMPONENTS	MATERIALS	PLATING(μm)
BODY	BRASS	BBR 2
MALE CENTER CONTACT	BRASS	GOLD 1.3 OVER COPPER 2.5
FEMALE CENTER CONTACT	BERYLLIUM COPPER	GOLD 1.3 OVER COPPER 2.5
OUTER CONTACT	BRASS	BBR 2
INSULATOR	PTFE	
GASKET		
SUBSTRATE	ALUMINA	
RESISTOR	THICK FILM	
OTHERS PARTS		

Issue : 0805 C

In the effort to improve our products, we reserve the right to make changes judged to be necessary.



6GHZ 1W 4DB QMA ATTENUATOR**R411.704.124**Series :
ATTENUATEUR**ELECTRICAL CHARACTERISTICS**

Frequency (GHz)	2	2 - 6
V.S.W.R (\leq)	1.20	1.30
Deviation(\pm dB)	0.30	0.50

Operating Frequency Range		GHz
Impedance	50	Ω
Nominal Attenuation	4	dB
Peak power at 25°C (1 μ s, 1%)	100	W
Average power at 25°C	1	W (Free Air Cooled)
		W (Conduction Cooled)

MECHANICAL CHARACTERISTICS

Connectors QMA
Weight 6,2600 g

ENVIRONMENTAL CHARACTERISTICS

Operating temperature range	-40 / +85 °C
Storage temperature range	-40 / +85 °C

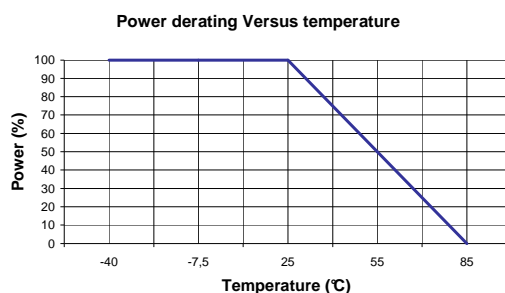
**SPECIFICATION****OTHER CHARACTERISTICS****Issue : 0805 C**

In the effort to improve our products, we reserve the right to make changes judged to be necessary.

RADIALL 